

Description

The DIODES™ AL3157 is a low noise, constant frequency charge pump DC/DC converter that uses a dual mode load switch (1x), and doubling (2x) conversion for driving white LEDs. Low external part count (one 1 μ F flying capacitor and two 2.2 μ F capacitors at V_{IN} and V_{OUT}) makes this part ideally suited for small, battery-powered applications.

The AL3157 drives 3 channels at up to 30mA for small screen backlighting and an additional channel up to 210mA for LED Flash or LED Flashlight – all from a 2.7V to 5.5V input.

The AL3157 uses two control inputs (EN1/2) to enable/disable it and PWM dim the LED current. EN2 controls/PWM dims the backlight LEDs at 30mA per channel and EN1 controls/PWM dims the Flash/Flashlight LEDs at 210mA.

Each output is equipped with built-in protection for V_{OUT} short circuit and auto-disable for LED failure conditions. Built-in soft-start circuitry prevents excessive in-rush current during start-up and mode switching. A low-current shutdown feature disconnects the load from V_{IN} to reduce quiescent current less than 1 μ A.

The AL3157 is available in a lead-free, space-saving thermally enhanced 12-pin 3mm x 3mm U-DFN3030-12 package.

Features

- Dual-Mode 1x and 2x Charge Pump
- Up to 300mA Drive Capability
 - 3-Channel for Backlight – 30mA/CH
 - Channel for Flash/Light – 210mA
- V_{IN} Range: 2.7V to 5.5V
- Two Simple PWM Dimming Control Inputs up to 50kHz
- 1.2MHz Constant Switching Frequency
- Built-in Thermal, Open-Circuit and V_{OUT} Short Circuit Protection
- Soft Start for Reducing In-Rush Current
- $I_Q < 1\mu A$ in Shutdown
- Thermally Enhanced U-DFN3030-12 Package: Available in “Green” Molding Compound (No Br, Sb)
- **Totally Lead-Free & Fully RoHS Compliant (Notes 1 & 2)**
- **Halogen and Antimony Free. “Green” Device (Note 3)**
- **For automotive applications requiring specific change control (i.e. parts qualified to AEC-Q100/101/104/200, PPAP capable, and manufactured in IATF 16949 certified facilities), please [contact us](#) or your local Diodes representative.**
<https://www.diodes.com/quality/product-definitions/>

Notes:

1. No purposely added lead. Fully EU Directive 2002/95/EC (RoHS), 2011/65/EU (RoHS 2) & 2015/863/EU (RoHS 3) compliant.
2. See <https://www.diodes.com/quality/lead-free/> for more information about Diodes Incorporated’s definitions of Halogen- and Antimony-free, “Green” and Lead-free.
3. Halogen- and Antimony-free “Green” products are defined as those which contain <900ppm bromine, <900ppm chlorine (<1500ppm total Br + Cl) and <1000ppm antimony compounds.

Pin Assignments

(Top View)

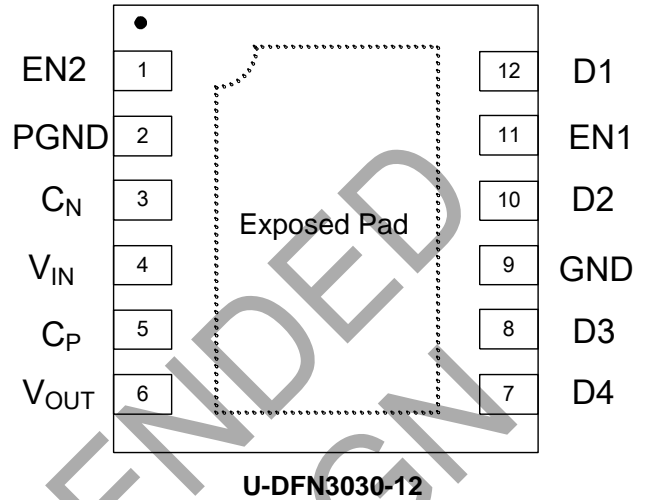

Applications

- Smart touch phone LED backlighting
- PDA white LED backlighting
- Backlighting + torch light

Typical Application Circuit

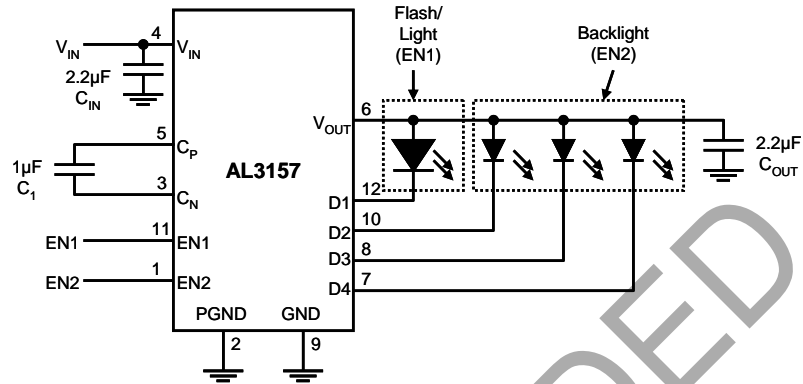

Pin Descriptions

Pin Name	Pin Number	Description
EN2	1	Enable Pin 2: Controls outputs D2, D3 and D4
PGND	2	Charge Pump Switch Ground: Connect to GND
CN	3	Negative Terminal of Flying Capacitor
V _{IN}	4	Input Power Supply. Decouple with a 2.2µF capacitor between this pin and ground.
CP	5	Positive Terminal of Flying Capacitor
V _{OUT}	6	Charge Pump Output to Drive D1 to D4 Load Circuit. Decouple with a 2.2µF capacitor between this pin and ground.
D4	7	Current Sink Input #4. Drive up to 30mA LED current. Connect to V _{OUT} when unused.
D3	8	Current Sink Input #3. Drive up to 30mA LED current. Connect to V _{OUT} when unused.
GND	9	Ground
D2	10	Current Sink Input #2. Drive up to 30mA LED current. Connect to V _{OUT} when unused.
EN1	11	Enable Pin 1: Controls output D1
D1	12	Current Sink Input #1. Drive up to 210mA LED current. Connect to V _{OUT} when unused.
Exposed Pad	EP Pad	Exposed Pad (bottom). Connect to GND directly underneath the package.

Functional Block Diagram

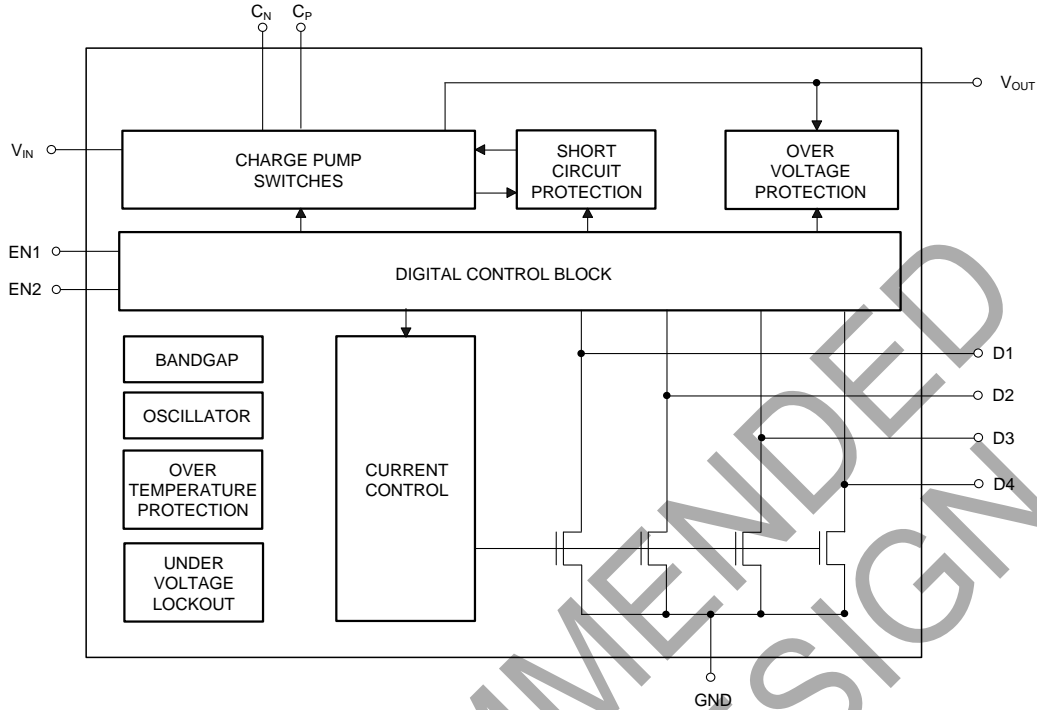

Absolute Maximum Ratings (Note 4)

Symbol	Description	Rating	Unit
ESD HBM	Human Body Model ESD Protection	2	kV
ESD MM	Machine Model ESD Protection	200	V
V _{IN}	Input Voltage	-0.3 to 6	V
V _{EN1, 2, 3}	EN1, EN2, EN3 to GND Voltage	-0.3 to V _{IN} +0.3	V
I _{OUT}	Maximum DC Output Current	300	mA
T _J	Operating Junction Temperature	+125	°C
T _{LEAD}	Maximum Soldering Temperature (at leads, 10 sec)	+300	°C

Note: 4. Stresses greater than those listed under *Absolute Maximum Ratings* can cause permanent damage to the device. These are stress ratings only, and functional operation of the device at these or any other conditions beyond those indicated under *Recommended Operating Conditions* is not implied. Exposure to *Absolute Maximum Ratings* for extended periods can affect device reliability.

Recommended Operating Conditions

Symbol	Parameter	Min	Max	Unit
V _{IN}	Input Voltage	2.7	5.5	V
V _{ENL(1, 2)}	EN1, 2 Threshold Low	0	0.4	V
V _{ENH(1, 2)}	EN1, 2 Threshold High	1.4	V _{IN}	V
T _A	Operating Ambient Temperature	-40	+85	°C

Electrical Characteristics ($V_{IN} = 4V$, $C_{IN} = C_{OUT} = 2.2\mu F$, $C_1 = 1\mu F$; $T_A = +25^\circ C$, unless otherwise noted.)

Symbol	Parameter	Test Conditions	Min	Typ.	Max	Unit
I _Q	Quiescent Current	1x Mode, $3.0 \leq V_{IN} \leq 5.5$, Active No Load Current	—	0.3	0.6	mA
		2x Mode, $3.0 \leq V_{IN} \leq 5.5$, Active No Load Current	—	2	5	
I _{SHDN}	Shutdown Current	EN1, EN2 = 0	—	—	1	μA
I _{D2-4}	Backlight LED Drive Sink Current Accuracy (Note 5)	I _{DX} = 30mA	28.5	30	31.5	mA
I _{D1}	Flash/Light LED Drive Sink Current Accuracy (Note 5)	I _{D1} = 210mA	199.5	210	220.5	mA
I _{D-Match}	Current Matching Between Any Two Backlight LED Drive Current Sink Outputs (Note 6)	V _F : D2:D4 = 4V	—	1	2	%
R _{OUT}	Charge Pump V _{OUT} Open Loop Resistance	1x Mode	—	0.5	—	Ω
		2x Mode	—	4.5	—	
V _{TH-DX}	1x to 2x Transition Threshold at D2, D3 and D4 Pins	I _D = 30mA	—	150	—	mV
V _{TH-D1}	1x to 2x Transition Threshold at D1 Pin	I _{D1} = 210mA	—	150	—	mV
V _{HS}	Mode Transition Threshold	—	—	—	500	mV
t _{SS}	Soft-Start Time	—	—	100	—	μs
f _{SW}	Switching Frequency	—	—	1.2	—	MHz
t _{EN1,2}	EN1, 2 Off Timeout	—	—	—	20	ms
UVLO	V _{IN} Under-Voltage Lockout	—	1.8	2	2.2	V
I _{EN1,2}	EN1, 2 Input Leakage	—	-1	—	1	μA
T _{SHDN}	Thermal Shutdown Protection	—	—	+160	—	°C
T _{HYS}	Thermal Shutdown Hysteresis	—	—	+10	—	°C
θ _{JA}	Thermal Resistance Junction-to-Ambient	U-DFN3030-12 (Note 7)	—	55.29	—	°C/W

- Notes:
- Determined by the mean of channels 2, 3 and 4 currents, EG $(I_{D2} + I_{D3} + I_{D4})/3$.
 - Determined by the maximum sink current (MAX), the minimum sink current (MIN), and the average sink current (AVG). Two matching numbers are calculated as $(MAX-AVG)/AVG$ and $(AVG-MIN)/AVG$. The largest number of the two (worst case) is as the matching data.
 - Device mounted on FR-4 substrate, 2" x 2", 2oz copper, double-sided PC board.

Typical Performance Characteristics

Turn-On in 1x Mode

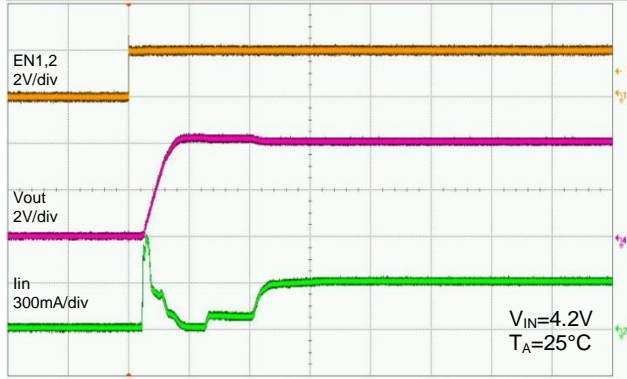

100µs/div

Turn-On in 2x Mode

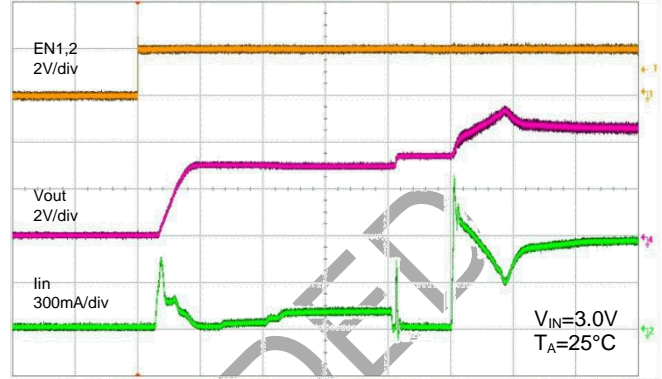

100µs/div

Turn-Off in 1x Mode

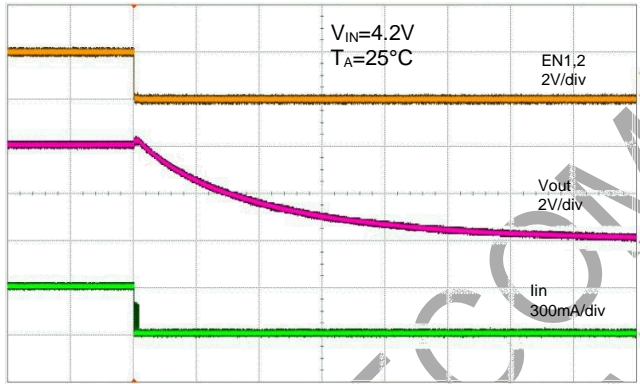

200ms/div

Turn-Off in 2x Mode

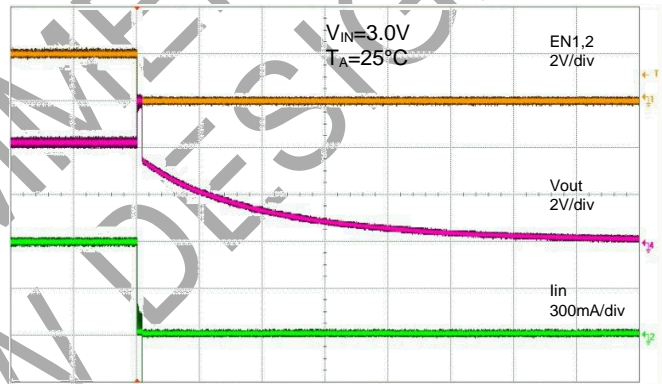

200ms/div

Load Characteristics in 2x Mode

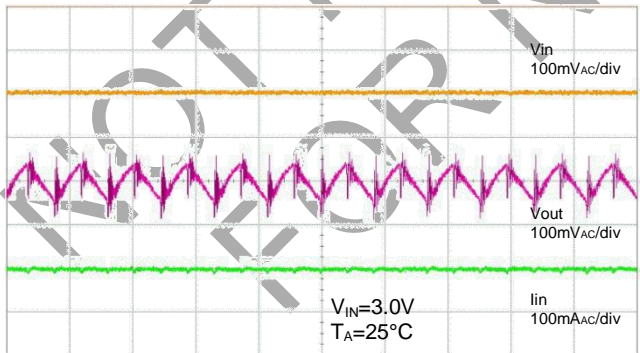

500ns/div

PWM Dimming Control (Duty Cycle=50%)

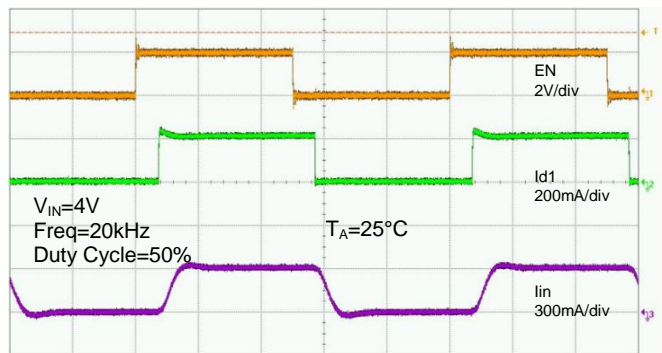

10µs/div

Typical Performance Characteristics (continued)

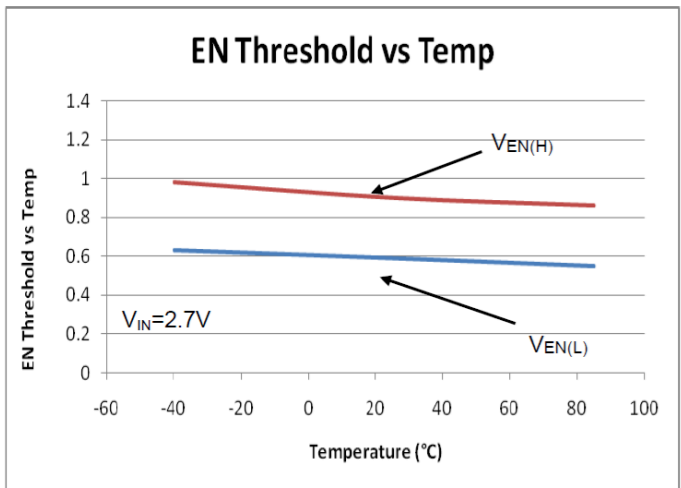
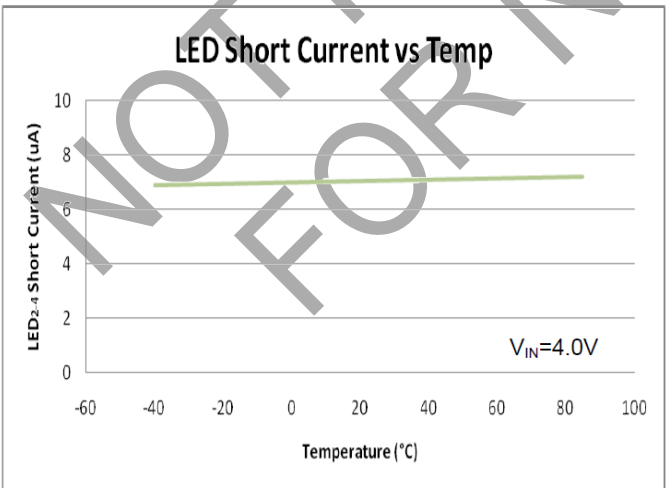
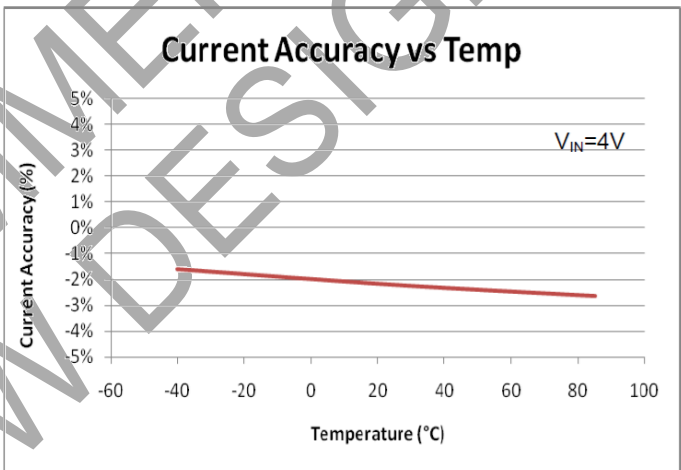
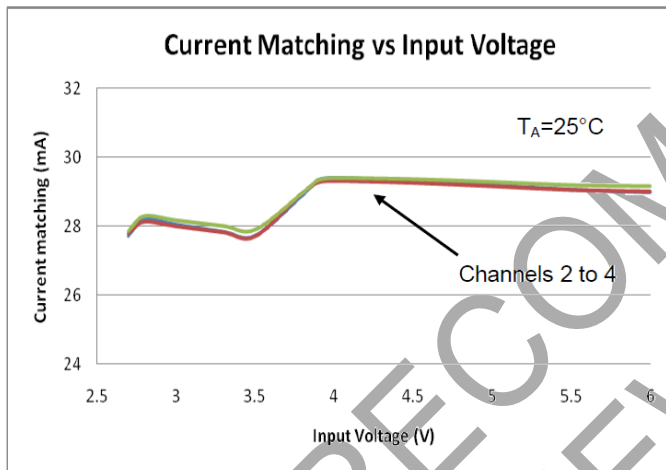
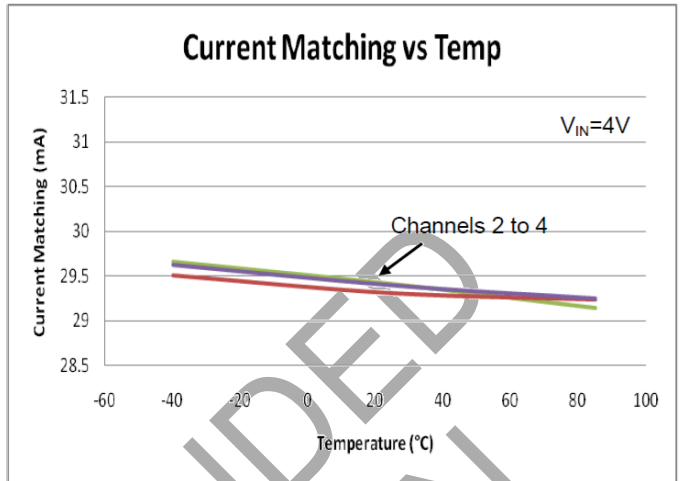
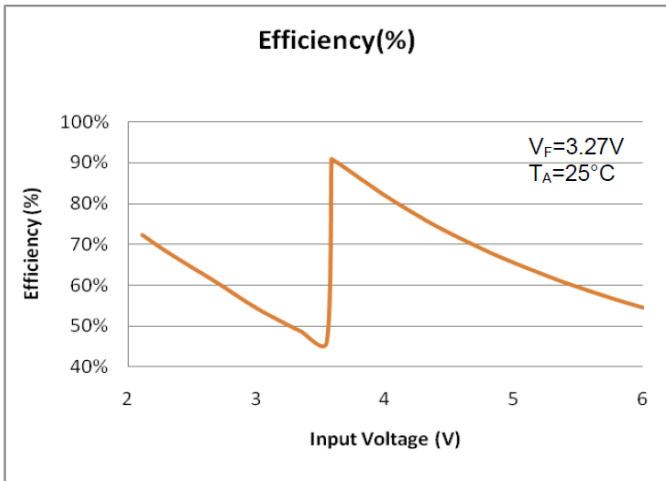

Functional Description

The AL3157 is a dual-mode high efficiency charge pump (1x and 2x) device, driving 3-channel standard backlight LEDs and one high-current Flash/Torch LED, intended for white LED backlight applications. An internal comparator circuit compares the voltage at each constant current sink input against a reference voltage. To ensure maximum power efficiency, the most appropriate switching mode (1x and 2x) is automatically selected.

The APL3157 requires only three external components: one 1 μ F ceramic flying capacitor (C_1) for the charge pump, one 2.2 μ F ceramic input capacitor (C_{IN}), and one 2.2 μ F ceramic charge pump output capacitor (C_{OUT}).

Each output channel of the AL3157 can drive three individual LEDs with a maximum current of 30mA per channel and a Flash/Torch LED with a maximum current of 210mA. These can be paralleled to give a total output current of 300mA.

LED Control Table

EN1	EN2	D1	D2, D3, D4
0	0	OFF	OFF
0	1	OFF	ON
1	0	ON	OFF
1	1	ON	ON

Disabled Current Sinks

Unused current channels must be disabled by connecting the sinks to V_{OUT} with only a small sense current flowing through the disabled channel.

Soft-Start

Soft-start is incorporated to prevent excessive in-rush current during power-up, mode switching, and transitioning out of stand-by mode.

Short-Circuit Protection

Short-circuit protection function is incorporated to prevent excessive load current when either flying cap terminals or output pin electrically tied to a very lower voltage or ground.

Over-Voltage Protection

Over-voltage protection function is incorporated to limit the output voltage under a safe value to avoid on-chip device breakdown.

Under-Voltage Lockout

Under-voltage lockout feature disables the device when the input voltage drops below UVLO threshold.

Thermal Auto Shutdown

When the die temperature exceeds the thermal limit, the device will be disabled and enter stand-by mode. The operation resumes whenever the die cools off sufficiently.

PWM Dimming Control

The AL3157 provides simple PWM dimming control through ENx pins, and the current is adjusted by the duty cycle of the signal applied on ENx pin. The recommended PWM frequency is from 200Hz to 50kHz depending on applications.

Ordering Information

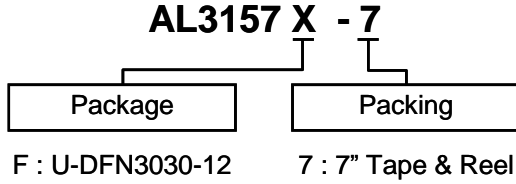

Part Number	Part Number Suffix	Package Code	Package (Note 8)	Packing	
				Qty.	Carrier
AL3157F-7	-7	F	U-DFN3030-12	3000	7" Tape and Reel

Note: 8. Pad layout as shown on Diodes Incorporated's suggested pad layout, which can be found on our website at <http://www.diodes.com/package-outlines.html>.

Marking Information

U-DFN3030-12

(Top View)

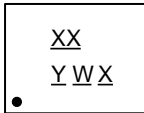

XX : B7 : AL3157
 Y : Year : 0 to 9 (ex: 2 = 2022)
 W : Week : A to Z : week 1 to 26;
 a to z : week 27 to 52;
 z represents week 52 and 53
 X : A to Z : Green

Part Number	Package	Identification Code
AL3157F-7	U-DFN3030-12	B7

NOT RECOMMENDED FOR NEW DESIGN

Package Information

Please see <http://www.diodes.com/package-outlines.html> for the latest version.

Package Type: U-DFN3030-12

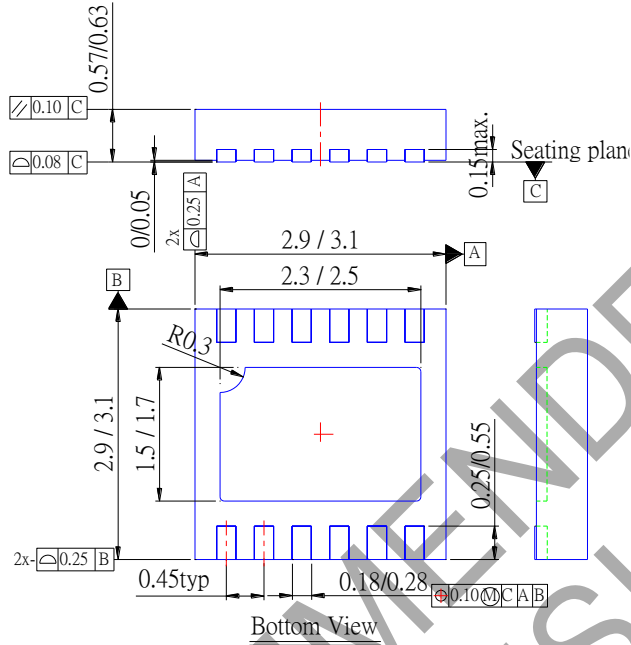

Tape Orientation (Note 9)

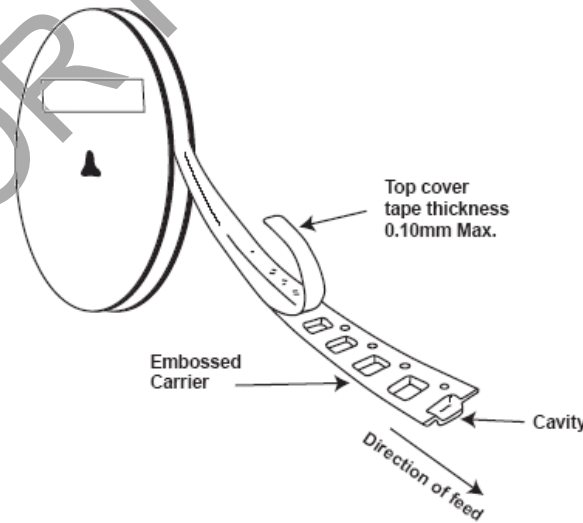
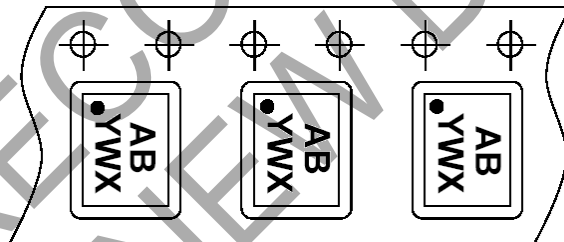

Note: 9. The taping orientation of the other package type can be found on our website at <https://www.diodes.com/assets/Packaging-Support-Docs/ap02007.pdf>.

IMPORTANT NOTICE

1. DIODES INCORPORATED (Diodes) AND ITS SUBSIDIARIES MAKE NO WARRANTY OF ANY KIND, EXPRESS OR IMPLIED, WITH REGARDS TO ANY INFORMATION CONTAINED IN THIS DOCUMENT, INCLUDING, BUT NOT LIMITED TO, THE IMPLIED WARRANTIES OF MERCHANTABILITY, FITNESS FOR A PARTICULAR PURPOSE OR NON-INFRINGEMENT OF THIRD PARTY INTELLECTUAL PROPERTY RIGHTS (AND THEIR EQUIVALENTS UNDER THE LAWS OF ANY JURISDICTION).
2. The Information contained herein is for informational purpose only and is provided only to illustrate the operation of Diodes' products described herein and application examples. Diodes does not assume any liability arising out of the application or use of this document or any product described herein. This document is intended for skilled and technically trained engineering customers and users who design with Diodes' products. Diodes' products may be used to facilitate safety-related applications; however, in all instances customers and users are responsible for (a) selecting the appropriate Diodes products for their applications, (b) evaluating the suitability of Diodes' products for their intended applications, (c) ensuring their applications, which incorporate Diodes' products, comply the applicable legal and regulatory requirements as well as safety and functional-safety related standards, and (d) ensuring they design with appropriate safeguards (including testing, validation, quality control techniques, redundancy, malfunction prevention, and appropriate treatment for aging degradation) to minimize the risks associated with their applications.
3. Diodes assumes no liability for any application-related information, support, assistance or feedback that may be provided by Diodes from time to time. Any customer or user of this document or products described herein will assume all risks and liabilities associated with such use, and will hold Diodes and all companies whose products are represented herein or on Diodes' websites, harmless against all damages and liabilities.
4. Products described herein may be covered by one or more United States, international or foreign patents and pending patent applications. Product names and markings noted herein may also be covered by one or more United States, international or foreign trademarks and trademark applications. Diodes does not convey any license under any of its intellectual property rights or the rights of any third parties (including third parties whose products and services may be described in this document or on Diodes' website) under this document.
5. Diodes' products are provided subject to Diodes' Standard Terms and Conditions of Sale (<https://www.diodes.com/about/company/terms-and-conditions/terms-and-conditions-of-sales/>) or other applicable terms. This document does not alter or expand the applicable warranties provided by Diodes. Diodes does not warrant or accept any liability whatsoever in respect of any products purchased through unauthorized sales channel.
6. Diodes' products and technology may not be used for or incorporated into any products or systems whose manufacture, use or sale is prohibited under any applicable laws and regulations. Should customers or users use Diodes' products in contravention of any applicable laws or regulations, or for any unintended or unauthorized application, customers and users will (a) be solely responsible for any damages, losses or penalties arising in connection therewith or as a result thereof, and (b) indemnify and hold Diodes and its representatives and agents harmless against any and all claims, damages, expenses, and attorney fees arising out of, directly or indirectly, any claim relating to any noncompliance with the applicable laws and regulations, as well as any unintended or unauthorized application.
7. While efforts have been made to ensure the information contained in this document is accurate, complete and current, it may contain technical inaccuracies, omissions and typographical errors. Diodes does not warrant that information contained in this document is error-free and Diodes is under no obligation to update or otherwise correct this information. Notwithstanding the foregoing, Diodes reserves the right to make modifications, enhancements, improvements, corrections or other changes without further notice to this document and any product described herein. This document is written in English but may be translated into multiple languages for reference. Only the English version of this document is the final and determinative format released by Diodes.
8. Any unauthorized copying, modification, distribution, transmission, display or other use of this document (or any portion hereof) is prohibited. Diodes assumes no responsibility for any losses incurred by the customers or users or any third parties arising from any such unauthorized use.
9. This Notice may be periodically updated with the most recent version available at <https://www.diodes.com/about/company/terms-and-conditions/important-notice>

DIODES is a trademark of Diodes Incorporated in the United States and other countries.
The Diodes logo is a registered trademark of Diodes Incorporated in the United States and other countries.
© 2022 Diodes Incorporated. All Rights Reserved.

www.diodes.com